

# Data Sheet



Article number: 021816011276

Description: Clamp with bracket and rubber  
SPGU 6011. 276/30 SK

## Measures

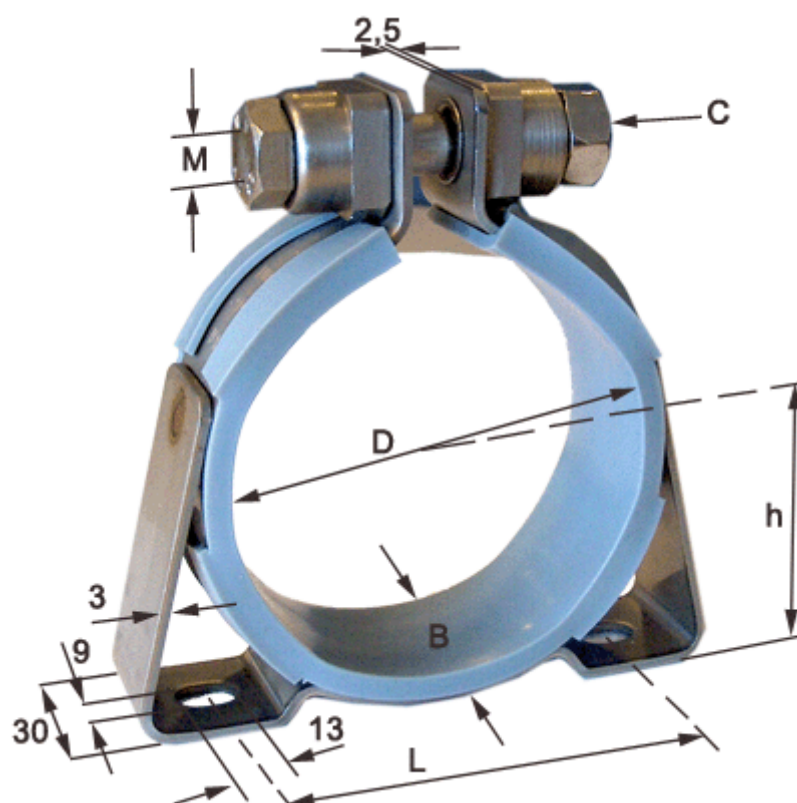

C (screw type) = SK hexagon screw

Diameter D = 276

h = 145

L = 248

Width B = 30